



LAVENDER HARVESTER AND AROMATIC HERBS HARVESTER



BONINO

BONINO



Super-personalized

Special Machines for harvesting herbs, medicinal herbs and leafy vegetables.

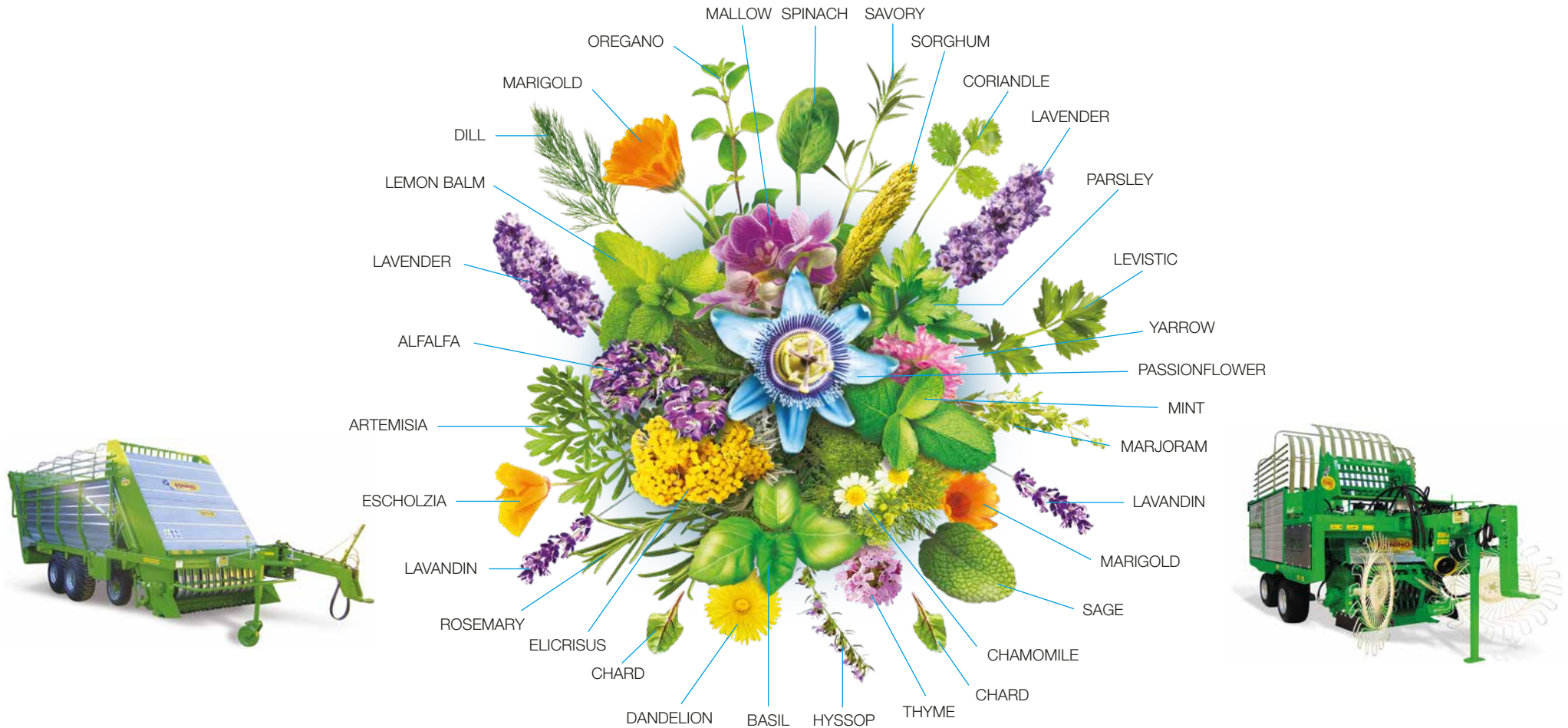

**Custom-designed to meet specific customer needs
and optimized for the type of product to harvest.**

For over 75 years, Bonino has stood out as an expert in the design and production of special machines (in towed version) for harvesting aromatic herbs, medicinal plants and leafy vegetables, custom-built to meet the most specific needs of our customers.

Every feature, from dimension to cutting systems, wheelbase and load capacity, are defined in collaboration with the customer to ensure a "super-customized" solution.

The ultimate expression of Bonino technology



BONINO MACHINE CONFIGURATION

We study the needs of customers.

We propose the best solutions according to our experience in the field.

We create the machine that suits each type of aromatic grass, the type of soil (clay, alkaline, etc.) the different pedo-climatic situations and the customer's needs.

EACH MACHINE, A UNIQUE PIECE TAILORED TO YOU!

THE TECHNICAL ASPECTS IN BRIEF

Product lifting brushes

The front brushes gently lift all the product and convey it to the cutting system.

Cutting system

3 cutting systems, 3 mowing bars adaptable to the size, height and texture of the herbs to be harvested.

Herb loading

A loading ladder conveys the cut product into the rear box. Due to its special shape and size, the stepladder allows the loading of long and short products.

Rear unloading

The unloading of herbs can be done in three ways:

- hydraulic door
- catenary that unloads the product directly into caissons or trailers
- a mat and a catenary that unloads the product laterally to the right or left.

Control systems

- Mechanical: with the help of flexible cables in the tractor cab
- Hydraulics: with direct hydraulic hoses from the tractor's hydraulic system
- Electrical: using an electric control panel in the tractor cab.



Three mowing bars, each one specific to harvest different types of crops



TWO TILTING DISCS

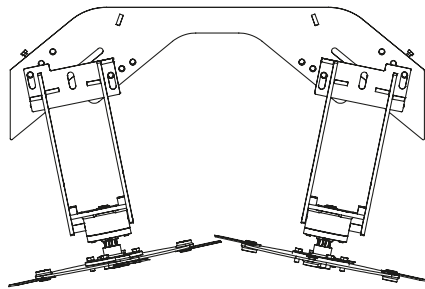

BE SERIES



TWO FIXED HORIZONTAL DISCS

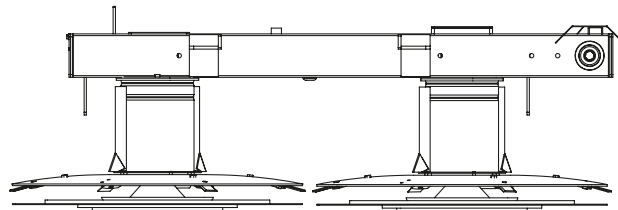

AROM SERIES



DOUBLE-BLADE BUSATIS

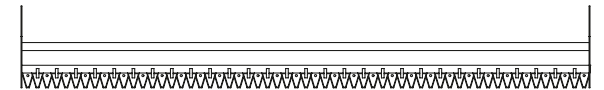

BE Series Lavender Harvester Mowers

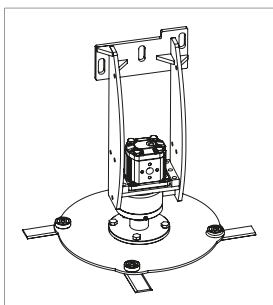

CUTTING HEIGHT

The two-disc mowing bar allows adjustment of height, width and cutting angle. The angle of the two discs can be varied to achieve the most suitable cutting angle for the crop to be harvested, taking into account the height of the plant and the maintenance of the bush shape. The cutting angle is vital in order not to damage the plant and ensure healthy growth for the next harvest. Each mower disc is equipped with 4 knives that enable a clean and precise cut of the crop. By varying the cutting height, the same machine (BE model) can be perfectly adapted to both lavender and lavandin crops. The cutting height can vary from 5 to 60 cm.

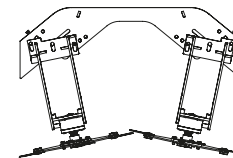

TRACK, AXLES AND WHEELS

Track width 1300 to 1700 mm

The lavender mower is equipped with 4 axles with variable track widths according to crop. The track width can vary from 1300 to 1700 mm.

Types of tires

You can choose from different types of wheels depending on the characteristics of the terrain: wider wheels for crumbly ground or to give more stability; designs suitable for all types of terrain; wheels with inner tubes or without. It is also possible to request the installation of a spare wheel kit including: a spare wheel housed on the rear door or supplied separately; a support foot for wheel replacement; provision the machine for replacement.

UNLOADING SYSTEMS

Hydraulic door:

allows the product to be unloaded on the ground, creating one or more piles that will then be introduced, with the appropriate forks, front lifts, grippers or conveyor belts, inside containers for subsequent extraction of the essential oil.

Vertical unloading:

allows freshly harvested lavender to be unloaded directly inside special containers, trailers or trucks and transported to the distillery or processing sites.

Another option allowed by this type of unloading is to release the lavender directly into the distillers for essential oil extraction.

With both methods, lavender can be unload to the ground, proceeding slowly forward to create a carpet of product that can dry evenly in the sun. Then one can proceed to compose scented bouquets. Alternatively, bring the lavender to the distillery to process it into essential oil.



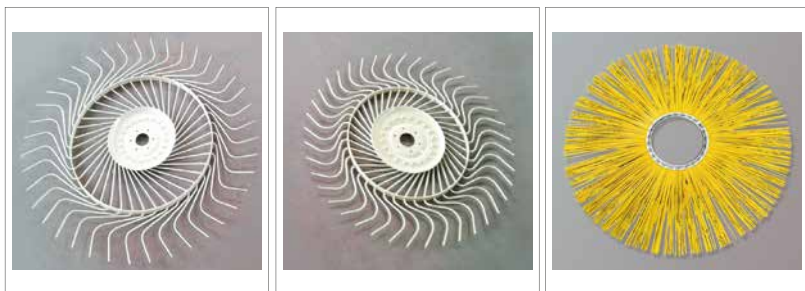

CONVEYING SYSTEM

The plant is conveyed to the center of the machine through two side rakes: the product is pushed gently toward the center to allow cutting across the full width.

Two different sizes of rakes can be chosen, depending on the quality of lavender or the type of product to harvest.

For delicate products, it is possible to equip the machine with propylene brushes: they have the same function as the rakes but act more delicately. A special adapter kit allows the brushes to be installed on the machine (even later after purchase).



OTHER FEATURES

Electronic control panel

All machine functions are activated via an electronic control panel located inside the tractor cab. The operator is able to cut, load and unload product without ever getting off the tractor.

Radiator

A special radiator has been introduced so that the plumbing system is not fatigued after many hours of consecutive work, even in locations and times of the year when temperatures are very high.

Metric rod

A special meter allows the user to select and maintain a constant and precise cutting height.

Access to the box

A side door provides access to the box, facilitated by the side ladder in the case of rear vertical unloading.

High drawbar

The high drawbar allows the machine structure to pass over the crop to be cut and the cut crop without damaging the plants.

Automatic lubrication

Automatic lubrication of the self-loading ladder ensures constant drop-by-drop lubrication of the catenaries on each side of the product ascent chain.

The various internal greasing points are easily accessible.



TILTING DISCS TO ENSURE BUSH SHAPE



BE SERIES Technical Data

	BE300	BE400	BE500	BE600
Total length (mm)	5800	6600	7600	8600
Box length (mm)	2400	3000	4000	5000
Maximum height (mm)	2800	3400	3420	3600
Minimum height (mm)	2100	2300	2300	2500
Maximum width (mm)	1900	2050	2050	2050
Volume DIN 11741 (m ³)	7	10	15	21
Cutter bar width (mm)	1000	1000	1000	1000
Tires	13.0/55x16 12PR IMPLEMENT	13.0/55x16 12PR IMPLEMENT	11.5/80x15.3 10PR IMPLEMENT	14.0/65x16 14PR IMPLEMENT
Axes	1	2	2	2
Wheel track width (mm)	1500	1300 to 1700	1300 to 1700	1300 to 1700
Spike bars	9	11	11	11
Weight (Kg)	2300	2690	3000	3530
Power required (HP)	60/70	60/70	70/80	80/90



AROM Series Aromatic Herb Harvester Mowers

Rotary cutter bar version with two fixed horizontal discs - Side drawbar and center drawbar

WITH TWO FIXED HORIZONTAL DISKS

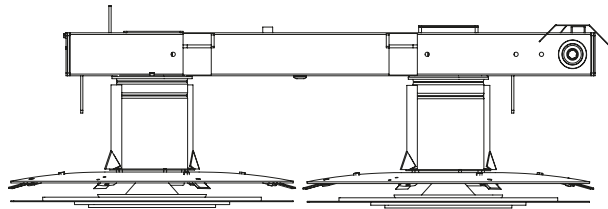

FOR ALL KINDS OF HERBS

These machines are suitable for cutting and harvesting all types of herbs, both in full-field and row crops.

CUTTING SYSTEM - The cutter bar with two fixed horizontal discs is equipped with 4 knives for each disc that allow a clean cut of various types of grasses even with more substantial and woody stems. With this type of cutter bar it is possible to adjust the cutting height, a height that can vary according to the configuration of the machine itself, thus according to each customer's needs. In case of short and light product, it is possible to equip the cutter bar with a kit to improve ventilation during harvesting operations. Also, to avoid product loss, slot closures can be inserted between the cutter bar and self-loading ladder. These machines are suitable for cutting and harvesting all types of herbs in both full-field and row crops.

CONVEYING SYSTEM - The crop can be conveyed to the center of the machine through two side brushes at each disc of the cutter bar: the crop is pushed gently toward the center to allow a cut across the entire width. Brushes of two different sizes can be chosen, depending on the type and size of the crop to be harvested. The conveyor system can be used or not according to one's needs.

LOADING SYSTEM - The loading ladder is equipped with spike bars that allow the product to be accompanied into the rear box, a facilitated unloading system facilitates the entry of the product into the box reducing possible pressure that could ruin the product. The loading ladder is totally enclosed to thus prevent any loss of product.

UNLOADING SYSTEMS - Hydraulic door - Side carpet - Side roller - Rear vertical unloading.

TRACKS, AXLES AND WHEELS - Standard measurements are as given in the data sheet. Other track/axles and wheels are possible at customer's request.

GENERAL FEATURES - Excellent adaptability to different grasses and seeding systems. - Minimal maintenance. Quick and easy replacement of knives. - Great maneuverability. Optimal cutting adjustment. - Adjustment of product conveying.

AROM Series Aromatic Herb Harvester Mowers

Rotary cutter bar version with two fixed horizontal discs - Side drawbar and center drawbar

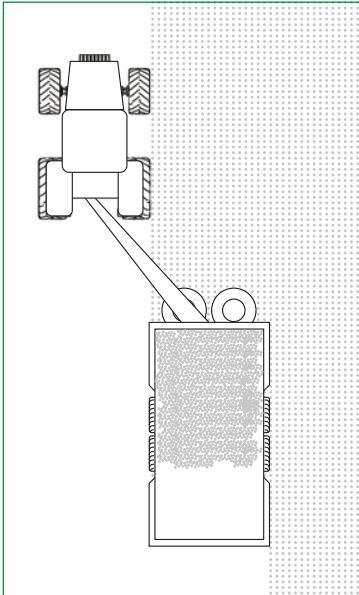

Full field
Side drawbar

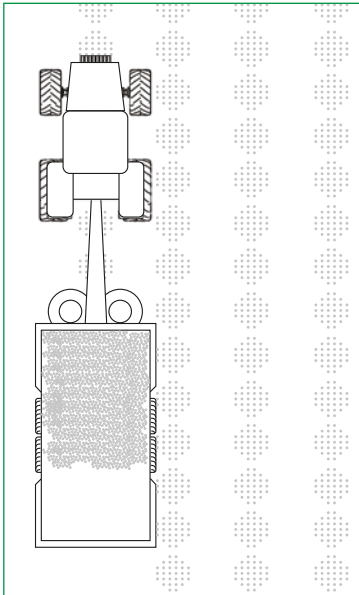

Row field
Central drawbar



MOWER CUSTOMIZATION FORM

By filling out a special form, the customer provides Bonino with a set of data about the way the machine will be operated: location of use of the machine, seeding system, type of plant to be harvested, height of cut, and end use of the product. The mower will be configured and customized according to the data provided. Thanks to the preventive study, it will be possible to assess in detail needs and appropriate solutions to improve the work of the final customer: reducing waste of time and product, ensuring an excellent quality of treatment of the product at every stage of its processing.

AROM SERIES - Cutter bar version with two fixed horizontal discs - Technical Data

	30	40	45	45 GV	50	60	70	75
Total length (mm)	6300	7200	7200	7200	7900	8400	8900	9700
Box length (mm)	3100+600	3300+600	3300+600	3300+600	4000+600	4500+600	5000+600	5500+600
Maximum height (mm)	2500	2800	2800	2900	2900	2900	2900	3100
Maximum width (mm)	2000	2150	2150	2150	2150	2150	2150	2150
Loading capacity (m ³)	13	17	18	19	20	24	28	35
Volume DIN 11741 (m ³)	8	10	11	12	14	16	18	22
Cutter bar width (mm)	1650	1850	1850	1850	1850	1850	1850	1850
Tires	10.0/75x15.3 PR 10	11.5/80x15.3 PR 10	11.5/80x15.3 PR 10	400/60x15.5 PR 14	11.5/80x15.3 PR 10	400/60x15.5 PR 14	400/60x15.5 PR 14	400/60x15.5 PR 14
Axes	1	1	1	1	2	2	2	2
Spike bars	6	8	8	8	8	8	8	9
Weight (Kg)	1950	2100	2300	2350	2700	2800	3200	3700
Power required (HP)	40/50	40/50	50/60	50/60	70/80	70/80	80/90	80/90 4 WD



AROM Series Aromatic Herb Harvester Mowers

Busatis double blade mowing bar version

BUSATIS DOUBLE BLADE CUTTER BAR

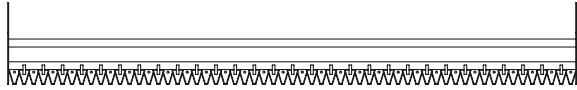

FOR DELICATE PLANTS THAT NEED TO REMAIN INTACT

These machines are suitable for cutting and harvesting delicate and tender plants that must remain intact, e.g., parsley, basil, marjoram, spinach, chard, etc., and be used as fresh or minimally processed products.

CUTTING SYSTEM - The Busatis double-blade cutter bar is equipped with two robustly designed blades that, thanks to a high cutting speed, allow for a clean and precise cut of the crop. The blade sections are patented ESM Carbodux® and require minimal maintenance. Its unique design and fast processing speed allow to cut and harvest the product, leaving it clean.

LOADING SYSTEM - The loading ladder is equipped with spike bars that allow the product to be accompanied into the rear box. The spike bars are equipped with closely spaced tips that allow precise loading without product loss even for very short products. A facilitated unloading system facilitates product entry into the bin by reducing possible pressure that could spoil the product. The loading ladder is totally enclosed to prevent any loss of product.

UNLOADING SYSTEMS - Hydraulic door - Side conveyor - Vertical unloading.

TRACKS, AXLES AND WHEELS - Standard measurements are as given in the data sheet. Other track/axles and wheels are available upon customer request.

GENERAL FEATURES

Robust design for optimal harvesting results.

Minimal maintenance.

Great maneuverability.

Minimal energy consumption.

Vibration-free cutting.

Optimal cutting adjustment.



Ladder with close tips



Vertical unloading



MOWER CUSTOMIZATION FORM - By filling out a special form, the customer tells Bonino a set of data related to the way the machine will be used: place of use of the machine, seeding system, type of plant to be harvested and cutting height, and end use of the product. The machine will be configured and customized according to the data provided. Thanks to the preventive study, it will be possible to assess in detail needs and appropriate solutions to improve the end customer's work: reducing waste of time and product, ensuring an excellent quality of product treatment at every stage of its processing.

AROM SERIES - Busatis Double Blade Cutterbar Version - Technical Data

	50 DL	60 DL	70 DL	75 DL
Total length (mm)	8000	8500	9000	9800
Box length (mm)	4000+600	4500+600	5000+600	5500+600
Maximum height (mm)	2900	2900	2900	3100
Maximum width (mm)	2400	2400	2400	2400
Loading capacity (m ³)	20	24	28	35
Volume DIN 11741 (m ³)	14	16	18	22
Cutter bar width (mm)	1700	1700	1700	1700
Tires	11.5/80x15.3 PR 10	400/60x15.5 PR 14 TRACTION	400/60x15.5 PR 14 TRACTION	400/60x15.5 PR 14 TRACTION
Axes	2	2	2	2
Spike bars	12	12	12	12
Weight (Kg)	3000	3150	3300	3900
Power required (HP)	70/80	70/80	80/90	80/90 4 WD



Aromatic herbs. Why grow them?

Herb cultivation can be **a sustainable agricultural activity**, as it requires less water and land resources than other crops and contributes to **biodiversity** of farming ecosystems. It is also a stimulus to the development of local and organic agriculture.

Aromatic herbs can enrich dishes with their unique flavors and aromas, reducing dependence on salt, seasonings, and artificial additives. These plants not only add **flavor** to our meals, but can also offer health **benefits** due to their nutritious and therapeutic **properties**. The cultivation and use of herbs are conducive to a **healthy and sustainable lifestyle**.

Why choose Bonino Super-custom mowers?

Choosing Bonino machines means relying on a trusted brand known for its quality, innovation, adaptability and customer support, helping to improve the efficiency and profitability of farming operations.

After harvesting with Bonino machines, distillation, drying or preparation of the fresh product can be carried out

DISTILLATION: distillation of herbs involves the extraction of essential oils by a stream of steam.

DRYING: drying should be done immediately after harvest to preserve the herbs' quality characteristics, including their vibrant colors and intense aroma.

USE OF THE FRESH PRODUCT: Bonino has designed special machines for cutting and harvesting plants that must remain intact to be used as fresh products. The transition from harvesting to use must be very short to preserve the quality and organoleptic characteristics intact.

SECTORS OF USE OF AROMATIC HERBS: medicine due to their medicinal properties, cosmetics, perfumery, and herbalism. A wide use is in cooking in the form of fresh, dried or crushed leaves to enrich and flavor dishes.



A success story that began more than 70 years ago



In 1946, Antonio Bonino founded an agricultural machinery repair and sales workshop in a small town in the province of Cuneo, marking the beginning of an extraordinary entrepreneurial adventure. Guided by his vision and talent, the small firm grew rapidly into a leading manufacturer in the industry.

Antonio aspired to design and manufacture innovative machines capable of responding to the growing needs of ever-evolving agriculture. In the 1970s, his vision was realized with the production of the first Self-Propelled Self-Loading Mower, followed by a series of special machines for the livestock sector, customized for each individual client farm.



His son Matteo, heir to his father's talent and passion, has carried on the family legacy, making Trailed Self-Loading Mowers increasingly suited to the global needs of an ever-changing market. He has also developed innovative solutions for herb harvesting, continuing his father's commitment to offering customized, high-quality products.



Today, with the contribution of children Dario and Cristina, the company continues to grow and expand, exporting its products to more than 40 countries around the world. The tireless entrepreneurial spirit and dedication to quality remain the hallmarks of the Bonino Company, always ready to anticipate the future and meet the needs of its global customers.





www.lavenderharvester.com



www.boninoitaly.com